

**FEATURES**

1. 180-264VAC input
2. Class II driver, without FG, flicker free
3. Built in active PFC function, high PF, low THD
4. Standby power consumption <0.5W to turn off dimmable port
5. Built in 1-10V/10V PWM dimming function
6. Constant current mode output with multiple levels selectable by DIP switch
7. Supporting multi-power supplies synchronous dimming connected in parallel
8. Cooling by free air convection
9. Suitable for indoor LED lighting applications
10. 5 years warranty

**APPLICATION**

1. LED indoor lighting
2. LED office lighting
3. LED architectural lighting
4. LED panel lamp lighting

**MODEL CODE**

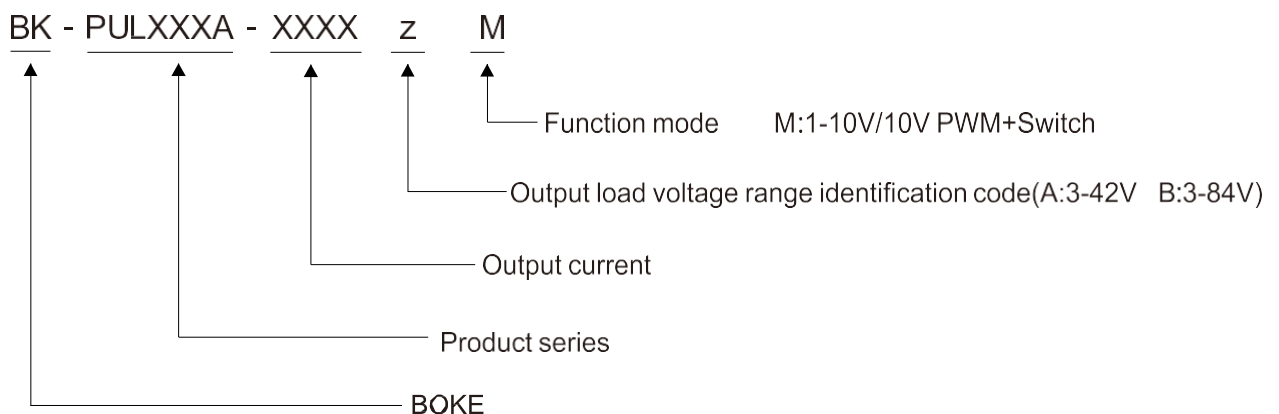

ELECTRICAL SPECIFICATION			
MODEL	BK-PUL042A-0700BM Longlife-LED Art. Nr.: 2221	BK-PUL042A-1100AM Longlife-LED Art. Nr.: 2220	BK-PUL060A-2000AM Longlife-LED Art. Nr.: 2219
<b>OUTPUT</b>			
DC current	0.25-0.7A	0.6-1.1A	0.8-2.0A
DC voltage range	3-84V	3-42V	3-42V
Rated power	42W Max	42W Max	61.2W Max
Voltage ripple & noise note.2	≤200mV(Vpp)	≤200mV(Vpp)	≤200mV(Vpp)
Current ripple & noise	≤30mA(RMS)	≤30mA(RMS)	≤30mA(RMS)
Constnt current ADJ. range	DIP S.W	DIP S.W	DIP S.W
Constant current accuracy	±20mA	±30mA	±40mA
Line regulation	±20mA	±30mA	±40mA
Load regulation	±20mA	±30mA	±40mA
Dimming port output current	<1mA(When DIM+is shorted with DIM-)		
External PWM interface	N/A		
<b>INPUT</b>			
Rated voltage	200-240VAC 200-240VDC		
Input AC voltage range	180-264VAC		
Input DC voltage range	180-264VDC		
Frequency range	47-63Hz		
Power factor	PF>0.95 @ 230VAC/full load,PF>0.90 @ 230VAC/>50% load		
Total harmonic distortion	THD<15% @ 230VAC/full load,THD<20% @ 230VAC/>50% load		
Efficiency (Typ.)	87%	89%	88%
Standby power note.3	<0.5W @ 230Vac	<0.5W @ 230Vac	<0.5W @ 230Vac
Input current	<0.2A @ 230Vac	<0.3A @ 230Vac	<0.3A @ 230Vac
Inrush current(Typ.)	Cold start <30A(Twidth=120us measured at 50% Ipeak) @ 230Vac.		
Max. No. of PSUs on 16A circuit breaker	25 units(circuit breaker of type B)/32 units(circuit breaker of type C);at 230VAC.		
Turn on delay	<0.5s @ 230Vac		
<b>PROTECTION</b>			
Short circuit	Hiccup,recovers automatically after environment temperature declines		
Max output voltage	50V	100V	50V
Over temperature	Hiccup,recovers automatically after fult condition is removed		
<b>ENVIROHMENT</b>			
Operation temperature	- 2 0 - 4 5°C		
Operation humidity	1 0 - 9 0 % R H , n o n - c o n d e n s i n g		
Storagr tempera-ture/humidity	- 4 0 - 8 0°C, 5 - 9 5 % R H		
IP class	IP20		
Vibration	10~500Hz,5G 12min./1cycle,period for 72min. each along X,Y,Z axes		
Tc	Tc=75°C(Ta=45°C)	Tc=75°C(Ta=45°C)	Tc=75°C(Ta=45°C)
MTBF	500000H,MIL-HDBK-217F(25°C)		
LIFETIME	See life curve for details		
<b>EMC</b>			
EMC emisson Note.4	Compliance to EN55015,GB17743,EN61000-3-2 Class C(≥30% load),EN61000-3-3		
EMC immunity	Compliance to EN61000-4-2,3,4,5,6,8,1,EN61547,surge:DM 2KV		
<b>SAFETY</b>			
Safety standards	EN61347-1/2-13,GB19510.1/14,EN62384,IEEE1789		
Dali standards	IEC62386-101,102,207		
Certificate	CE-SUD ENEC CCC SAA RCM		
Withstand voltage	I/P-O/P:3750VAC		
Leakage current	<0.7mA @ 240Vac		
Isolation resis-tance	I/P-O/P:100MΩ/500Vdc/25°C/70% RH		
<b>CONNECTOR</b>			
Environmental protection	RoHS		
Input connection	PCB connector/2PIN/orange+orange/PUL030A PUL042A:0.75-1.5mm^2/PUL060A:0.75-2.0mm^2		
Output connection	PCB connector/4PIN/black+green+red+black/0.5-1.5mm^2		
1.All parameter are measured at 230VAC input,rated load and 25°C of ambient temperature.			
2. Ripple & Noise are measured at 20MHz of bandwidth by using a 12" twised pair-wire terminated with a 0.1uF & 47uF paralld capacitor.			
3.Stand-by power consumption is measured at dimmable off condition.			
5. The power supply is considers as a compent that wil be operated in combination with final equipment.Since EMC performance will be affected by the complete installation the final equipment manufactures must re-quality EMC directive on the complete installation again.			
5. If this driver used for led lighting, the TC should not higher than TC showed on the driver when the lighting working on the highest rated working tempreture.			

**Electrical characteristics**

**BK-PUL030A-0700AM Electrical characteristics(42V/0.7A)**

**THD vs. Load**

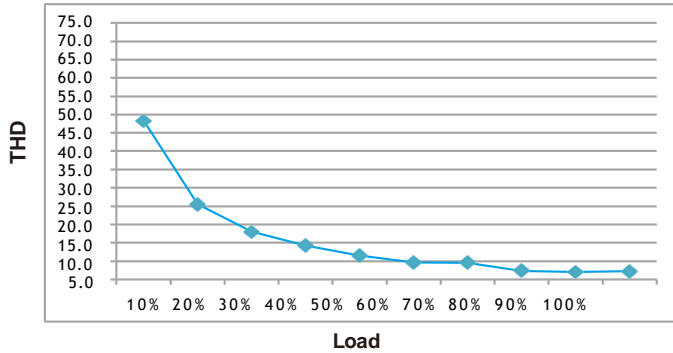

**Power factor vs. Load**

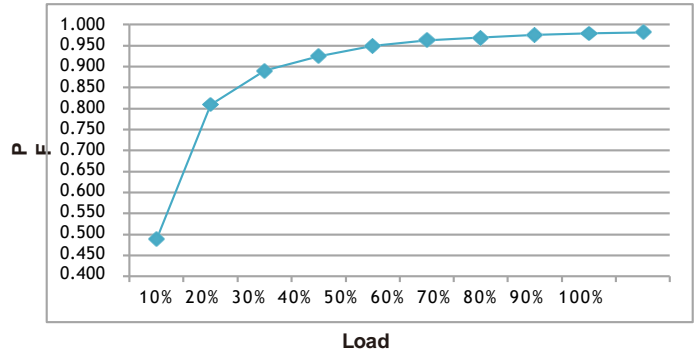

**Efficiency vs. Load**

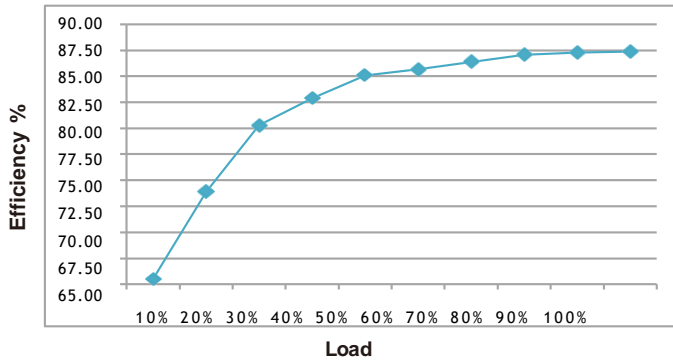

**Lifetime vs. case temperature**

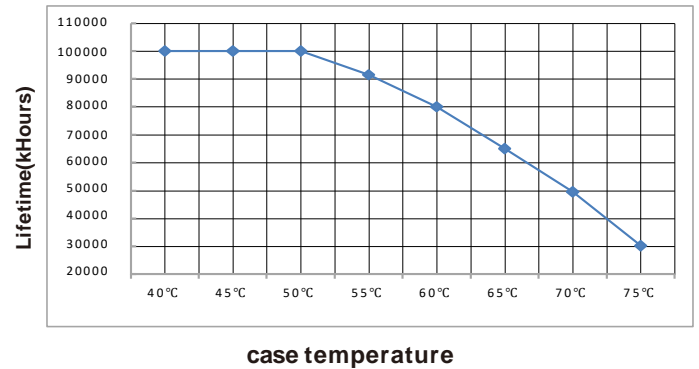

**BK-PUL042A-0700BM Electrical characteristics(84V/0.5A)**

**THD vs. Load**

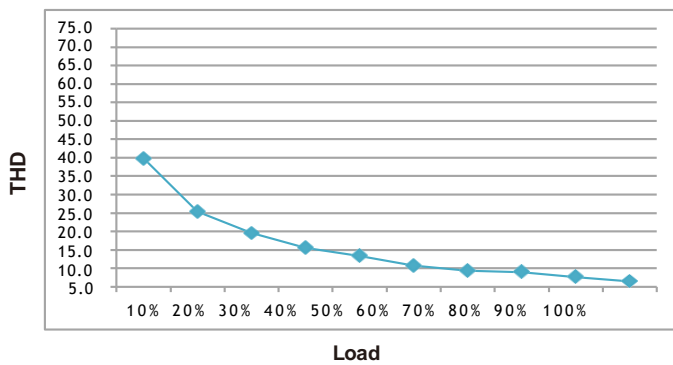

**Power factor vs. Load**

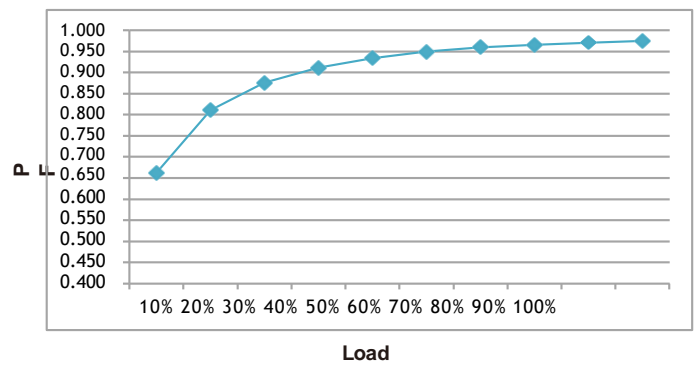

**Efficiency vs. Load**

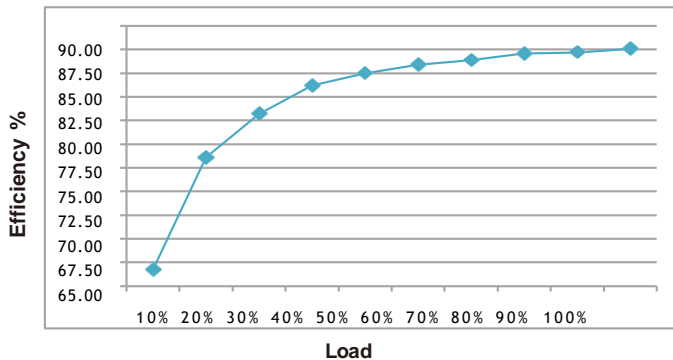

**Lifetime vs. case temperature**

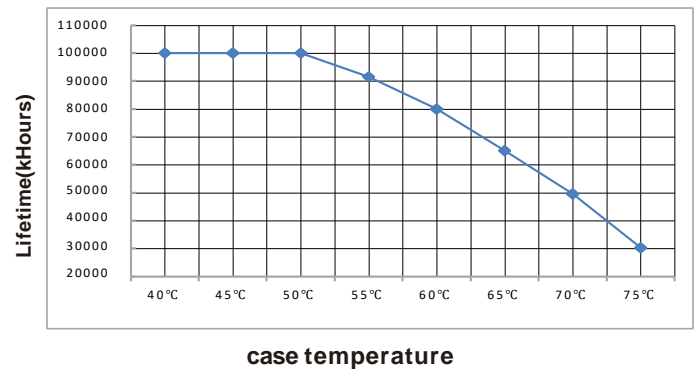

**Electrical characteristics**

**BK-PUL042A-1100AM Electrical characteristics(42V/1A)**

**THD vs. Load**

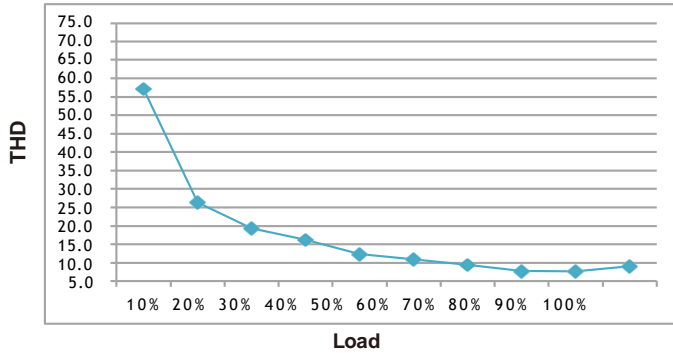

**Power factor vs. Load**

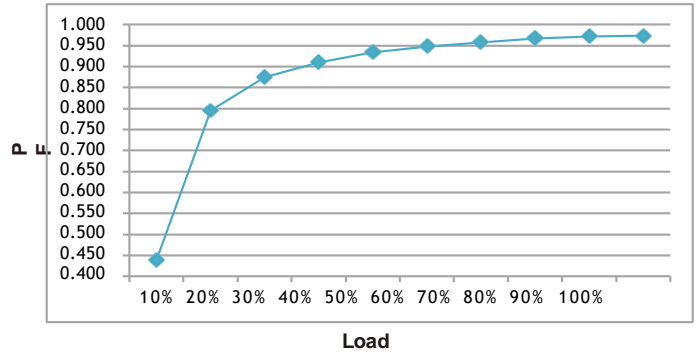

**Efficiency vs. Load**

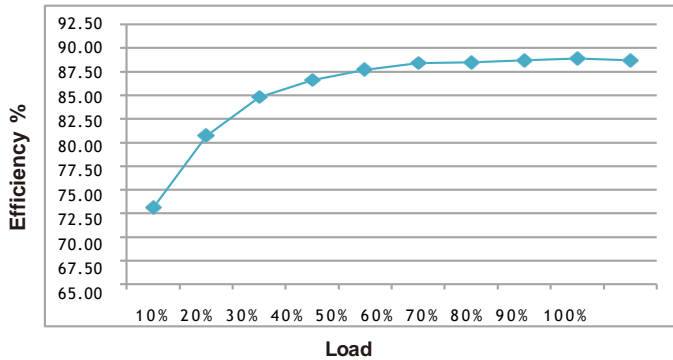

**Lifetime vs. case temperature**

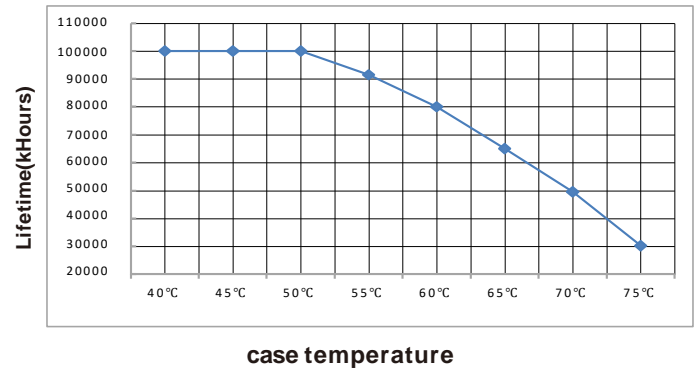

**BK-PUL060A-2000AM Electrical characteristics(42V/1.5A)**

**THD vs. Load**

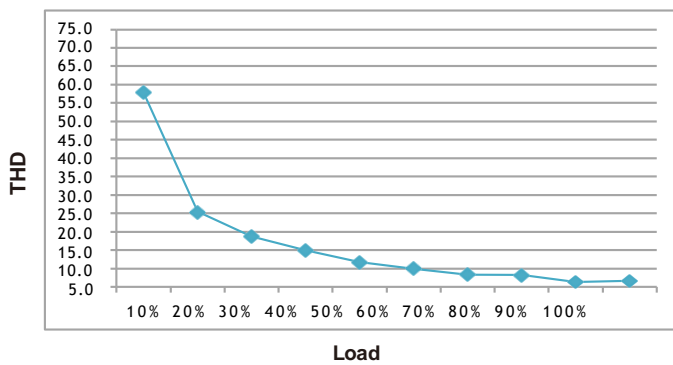

**Power factor vs. Load**

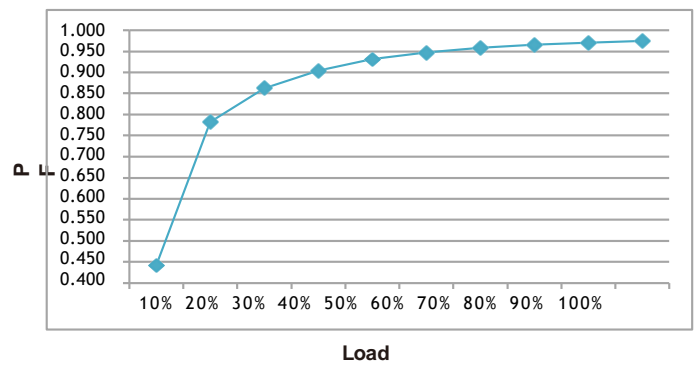

**Efficiency vs. Load**

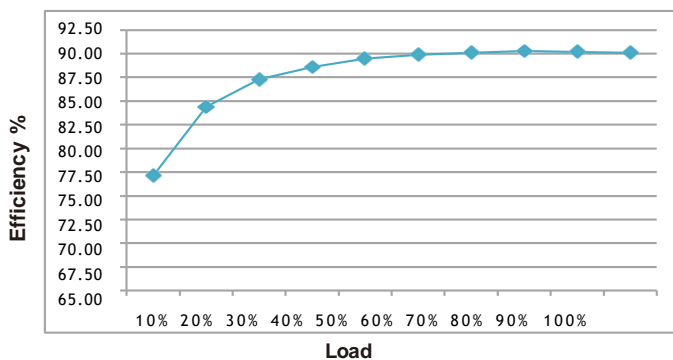

**Lifetime vs. case temperature**

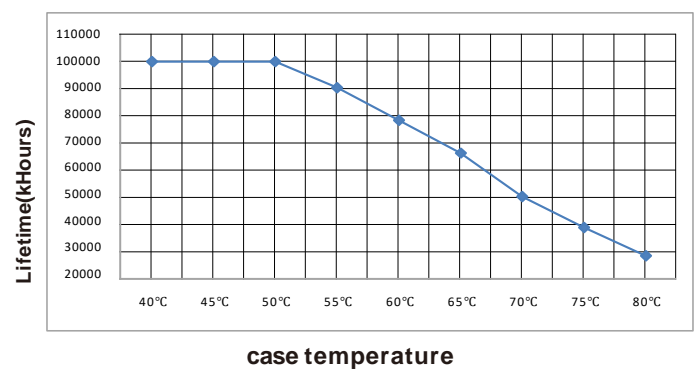

**DIP S.W Select output current table**

BK-PUL030A-0700AM

PIN typ.	Irated	Output Voltage	1	2	3	4
12.7W	250mA	42VDC	--	ON	ON	ON
14.9W	300mA	42VDC	ON	--	ON	ON
17.4W	350mA	42VDC	--	--	ON	ON
19.5W	400mA	42VDC	--	ON	--	ON
21.9W	450mA	42VDC	--	--	--	ON
24.3W	500mA	42VDC	ON	ON	ON	--
26.5W	550mA	42VDC	--	--	ON	--
28.9W	600mA	42VDC	--	ON	--	--
31.3W	650mA	42VDC	ON	--	--	--
33.7W	700mA	★ 42VDC	--	--	--	--

BK-PUL042A-0700BM

PIN typ.	Irated	Output Voltage	1	2	3	4
23W	250mA	84VDC	--	ON	ON	ON
28W	300mA	84VDC	ON	--	ON	ON
32W	350mA	84VDC	--	--	ON	ON
37W	400mA	84VDC	--	ON	--	ON
41W	450mA	84VDC	--	--	--	ON
46W	500mA	84VDC	ON	ON	ON	--
46W	550mA	76VDC	--	--	ON	--
46W	600mA	70VDC	--	ON	--	--
46W	650mA	64VDC	ON	--	--	--
47W	700mA	★ 60VDC	--	--	--	--

BK-PUL042A-1100AM

PIN typ.	Irated	Output Voltage	1	2	3	4
29W	600mA	42VDC		ON	ON	ON
34W	700mA	42VDC	ON	--	ON	ON
36W	750mA	42VDC	--	--	ON	ON
39W	800mA	42VDC	--	ON	--	ON
41W	850mA	42VDC	--	--	--	ON
43W	900mA	42VDC	ON	ON	ON	--
46W	950mA	42VDC	--	--	ON	--
48W	1000mA	42VDC	--	ON	--	--
48W	1050mA	40VDC	ON	--	--	--
48W	1100mA	★ 38VDC	--	--	--	--

BK-PUL060A-2000AM

PIN typ.	Irated	Output Voltage	1	2	3	4	5	6
38W	800mA	42VDC	ON	--	ON	--	ON	ON
43W	900mA	42VDC	--	--	--	--	--	ON
47W	1000mA	42VDC	ON	ON	ON	--	ON	--
52W	1100mA	42VDC	--	ON	ON	--	ON	--
54W	1150mA	42VDC	--	--	--	--	ON	--
56W	1200mA	42VDC	--	ON	ON	ON	--	--
59W	1250mA	42VDC	ON	--	ON	ON	--	--
61W	1300mA	42VDC	--	--	ON	ON	--	--
65W	1400mA	42VDC	--	ON	--	ON	--	--
68W	1500mA	40VDC	--	--	--	ON	--	--
69W	1600mA	38VDC	ON	ON	ON	--	--	--
69W	1700mA	36VDC	--	--	ON	--	--	--
69W	1800mA	34VDC	--	ON	--	--	--	--
69W	1900mA	32VDC	ON	--	--	--	--	--
69W	2000mA	★ 30VDC	--	--	--	--	--	--

Remark: ★ this current is factory default.

-- this channel is off.

**Lable**

**BOKE Dimmable Constant Current LED Driver**  
**MODEL: BK-PUL030A-0700AM**  
 INPUT: 200-240VAC 50/60Hz 0.2A Max λ = 0.95  
 OUTPUT: 60mA Max other ratings see below sheet

Switching selection sheet

PIN	Irated	Output Voltage	Rated	1	2	3	4
12.7W	250mA	3-42VDC	10.5W	--	ON	ON	ON
14.9W	300mA	3-42VDC	12.6W	ON	--	ON	ON
17.4W	350mA	3-42VDC	14.7W	--	--	ON	ON
19.5W	400mA	3-42VDC	16.8W	--	ON	--	ON
21.9W	450mA	3-42VDC	18.9W	--	--	--	ON
24.3W	500mA	3-42VDC	21.0W	ON	ON	ON	--
26.5W	550mA	3-42VDC	23.1W	--	--	ON	--
28.9W	600mA	3-42VDC	25.2W	ON	ON	ON	--
31.3W	650mA	3-42VDC	27.3W	ON	--	--	--
33.7W	700mA	3-42VDC	29.4W	ON	--	--	--

Before use, always check dipswitch settings!

•tc tc=75°C ta=45°C

For LED Modules use only

RoHS SELV

MADE IN CHINA

**BOKE Dimmable Constant Current LED Driver**  
**MODEL: BK-PUL042A-0700BM**  
 INPUT: 200-240VAC 50/60Hz 0.3A Max λ = 0.95  
 OUTPUT: 100mA Max other ratings see below sheet

Switching selection sheet

PIN	Irated	Output Voltage	Rated	1	2	3	4
24W	250mA	3-84VDC	21W	--	ON	ON	ON
28W	300mA	3-84VDC	25.2W	ON	--	ON	ON
32W	350mA	3-84VDC	29.4W	--	--	ON	ON
37W	400mA	3-84VDC	33.6W	--	ON	--	ON
42W	450mA	3-84VDC	37.8W	--	--	--	ON
47W	500mA	3-84VDC	42W	ON	ON	ON	--
47W	550mA	3-76VDC	41.8W	--	--	ON	--
47W	600mA	3-70VDC	42W	ON	ON	ON	--
47W	650mA	3-64VDC	41.8W	ON	--	--	--
48W	700mA	3-60VDC	42W	ON	--	--	--

Before use, always check dipswitch settings!

•tc tc=75°C ta=45°C

For LED Modules use only

RoHS SELV

MADE IN CHINA

**BOKE Dimmable Constant Current LED Driver**  
**MODEL: BK-PUL042A-1100AM**  
 INPUT: 200-240VAC 50/60Hz 0.3A Max λ = 0.95  
 OUTPUT: 50V Max other ratings see below sheet

Switching selection sheet

PIN	Irated	Output Voltage	Rated	1	2	3	4
29W	600mA	3-42VDC	25.2W	--	ON	ON	ON
34W	700mA	3-42VDC	29.4W	ON	--	ON	ON
36W	750mA	3-42VDC	31.5W	--	--	ON	ON
39W	800mA	3-42VDC	33.6W	--	ON	--	ON
41W	850mA	3-42VDC	35.7W	--	--	--	ON
43W	900mA	3-42VDC	37.8W	ON	ON	ON	--
46W	950mA	3-42VDC	39.9W	--	--	ON	--
48W	1000mA	3-42VDC	42W	ON	ON	ON	--
48W	1050mA	3-40VDC	42W	ON	ON	ON	--
48W	1100mA	3-38VDC	41.8W	ON	ON	ON	--

Before use, always check dipswitch settings!

•tc tc=75°C ta=45°C

For LED Modules use only

RoHS SELV

MADE IN CHINA

**BOKE Dimmable Constant Current LED Driver**  
**MODEL: BK-PUL060A-2000AM**  
 INPUT: 200-240VAC 50/60Hz 0.4A Max λ = 0.95  
 OUTPUT: 50V Max other ratings see below sheet

Switching selection sheet

PIN	Irated	Output Voltage	Rated	1	2	3	4	5	6
38W	800mA	3-42VDC	33.6W	ON	--	ON	--	ON	ON
43W	900mA	3-42VDC	37.8W	--	ON	ON	--	ON	ON
47W	1000mA	3-42VDC	42W	ON	ON	ON	--	ON	--
52W	1100mA	3-42VDC	46.2W	--	ON	ON	--	ON	--
54W	1150mA	3-42VDC	48.3W	--	--	ON	ON	--	--
56W	1200mA	3-42VDC	50.4W	ON	ON	ON	--	ON	--
59W	1250mA	3-42VDC	52.5W	ON	--	ON	ON	--	--
61W	1300mA	3-42VDC	54.6W	--	--	ON	ON	--	--
65W	1400mA	3-42VDC	58.8W	ON	ON	ON	--	ON	--
68W	1500mA	3-40VDC	63W	ON	ON	ON	--	ON	--
69W	1600mA	3-38VDC	63W	ON	ON	ON	--	ON	--
69W	1700mA	3-36VDC	61.2W	ON	ON	ON	--	ON	--
69W	1800mA	3-34VDC	61.2W	ON	ON	ON	--	ON	--
69W	1900mA	3-32VDC	60.8W	ON	ON	ON	--	ON	--
69W	2000mA	3-30VDC	60W	ON	ON	ON	--	ON	--

Before use, always check dipswitch settings!

•tc tc=80°C ta=45°C

For LED Modules use only

RoHS SELV

MADE IN CHINA

## 1-10VDC/10V PWM dimming

### Wiring diagram

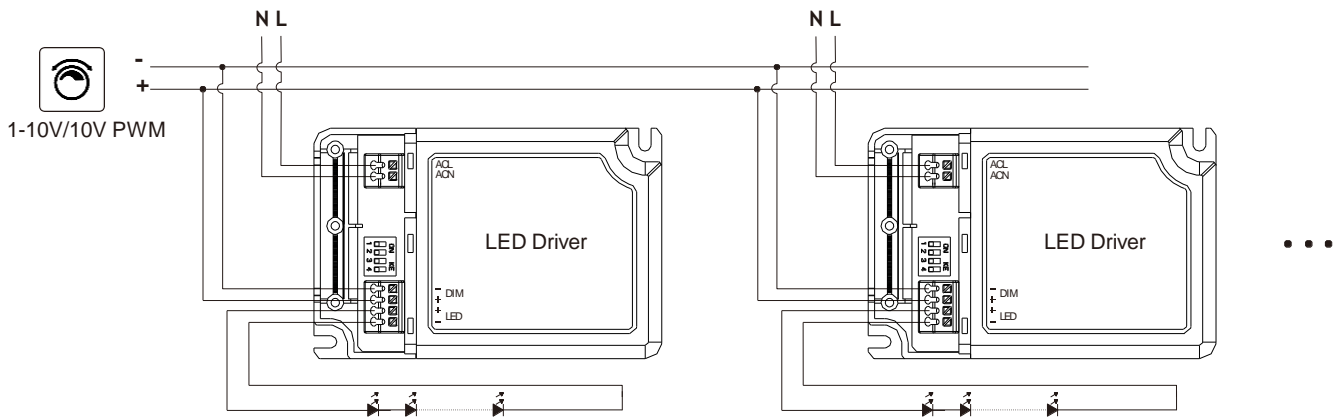

Please **DO NOT** connect "DIM-"to"LED-" or "DIM+"to"LED+".

### Note

1. Please carry out the sample or small batch test before the batch purchase.
2. The number of drives and the length of wire connections are determined by the following factors:
  - a. Current output capacity of the dimmer.
  - b. The interface of the driver consumes current, this product is less than 1mA.
  - c. The size of the connection wire, and is recommended to use less than 20AWG.
  - d. Install environmental interference, avoid wiring with high voltage or interference source. If you can't avoid it, you can consider using shield wire.
3. It is recommended that the number of drives and the dimming connection length are:  $\leq 20$  PCS,  $\leq 30$ m.
4. It is recommended to use a dimmer with active, isolated and strong output current capacity. The driver not support non-isolation dimmer.
5. This product is compatible with various active or passive dimmers. If a few dimmers are not compatible, it is a normal case and can be contacted us for confirmation.

### Dimming graph

Output current vs. Dimming Voltage(Typical)

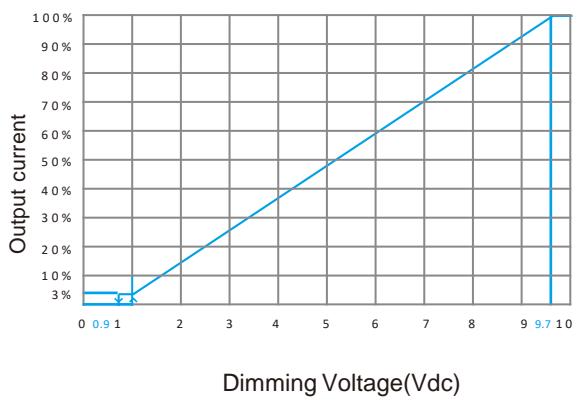

Output current 10V PWM Duty Cycle(Typical)

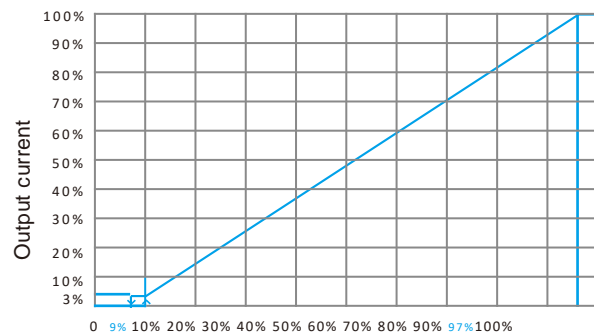

10V PWM Duty Cycle

\*Frequency range: 100Hz-3KHz

### Mechanical Specification

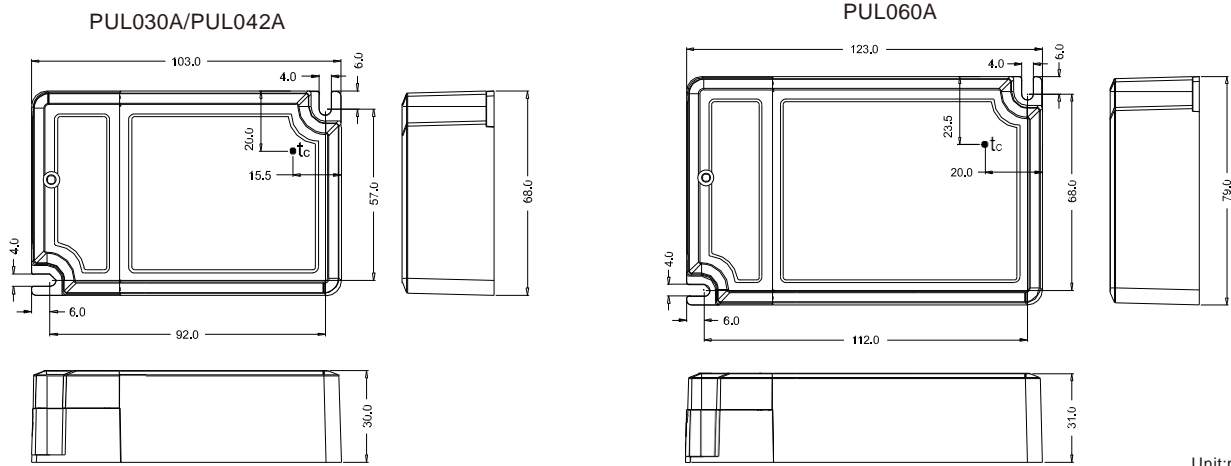

Unit:mm

### Product package

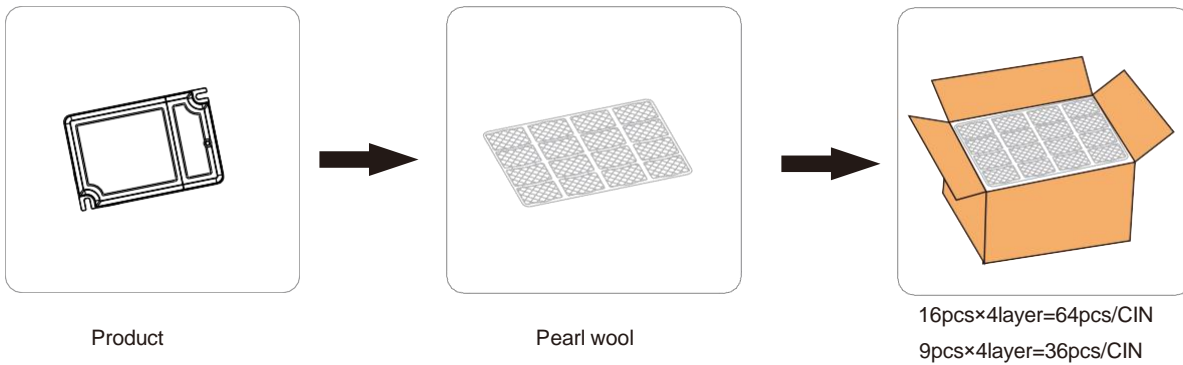

Product	Product size	Weight	Carton size	N.W	G.W	Pearl wool size	Flat card size	Packing
PUL030A	L103*W68*H30mm	140g	L490*W340*H165mm	9.96KG	10.5KG	L480*W330*H40mm	L480*W330mm	64pcs
PUL042A	L103*W68*H30mm	140g	L490*W340*H165mm	9.96KG	10.5KG	L480*W330*H40mm	L480*W330mm	64pcs
PUL060A	L123*W79*H31mm	240g	L450*W350*H180mm	9.3KG	9.88KG	L435*W345*H40mm	L435*W335mm	36pcs

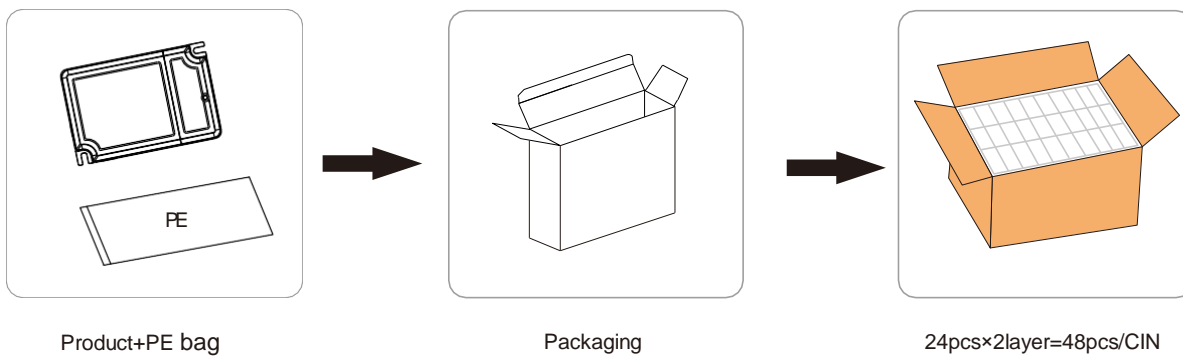

Product	Product size	Weight	Carton size	N.W	G.W	Packaging size	PE bag size	Packing
PUL030A	L103*W68*H30mm	170g	L415*W330*H190mm	7.9KG	9.4KG	L130*W38*H85mm	L250*W150mm	48pcs
PUL042A	L103*W68*H30mm	170g	L415*W330*H190mm	7.9KG	9.4KG	L130*W38*H85mm	L250*W150mm	48pcs
PUL060A	L123*W79*H31mm	250g	L415*W330*H190mm	11.5KG	13.2KG	L130*W38*H85mm	L250*W150mm	48pcs